



PropSava[®] SCRV

Power Optimisation System User & Installation Manual Mark VII – User Programmable System

Single Phase 230V Units

5KVA, 12KVA, 18KVA, 23KVA, 30KVA, 40KVA & 60KVA



Customer Support Contact

Distributor Name:

Distributor Telephone Number:

Email: customersupport@vanguardspower.com

Website: www.vanguardspower.com

Please Note: We have tried to faithfully reproduce the images and specifications in this document to the best of our ability based upon current information at the time of printing. However, due to on-going advances in our development program; manufacturing and legislation changes, these images and/or specifications may change without notice and therefore Vanguard's Power cannot accept any liability for any losses incurred by any party as a result of reliance on any statement, image or specification provided in this document.

Contents

Thank you:	1
Description:	1
Safety Features:	1
Purpose and Intended Use:	1
Mark VII Unique Features:	2
Layout Front:	3
Product Package Contents:	4
Safety Information:	4
Installation:	5
Wiring Diagrams:	7
1 st Post Installation Test – No Load	8
2 nd Post Installation Test – with Load:	8
Service and Maintenance:	8
Display & Control Panel – Description of Function and Controls:	9
How to Change PropSava Settings:	10
Display Screens:	11
Power Display Screen.....	11
Protection Display Screen	12
Events and Alarm Buzzer:	14
Muting the Alarm Buzzer:	14
Resetting the PropSava after an Alarm:	14
Working Principle:	14
Power Quality Management System (PQMS):	15
Specifications:	21
Surge Protection System:	22
PropSava Fault Finding and Recommendations for Electricians ONLY:	24
Declaration of Conformity:	25
Warranty Terms & Conditions	26
Warranty Card:	27

Thank you:

Thank you for purchasing the PropSava® Single Phase, Power Optimisation System. We believe it will provide you with many years of service, power and equipment savings.

Please read the following safety instructions and keep this User Manual available so that you can refer back to it at any time. You are permitted to make 3 copies of this User and Installation Manual. If you need any further copies please contact your Distributor.

Description:

The PropSava Single Phase SCR System is an automated hybrid voltage regulator and stabiliser; which uses solid state switches, transformers, sensors and control systems; managed by a state-of-the-art digital computer system. The PropSava is connected after the electric meter and site/building Master Breaker Switch and before the Distribution/Fuse Box. All power to a site/building passes through the PropSava.

Safety Features:

The PropSava has a number of standard safety features such as automated and manual By-Pass with surge protection. By-Pass is the system that can either automatically or manually shut down the regulating operation of the PropSava with immediate reconnection of input mains to output mains. Automatic By-Pass occurs when the PropSava identifies incoming voltage or power outside its designed range or if a fault occurs on either the input or output side of the power supply. There are also internal computer systems that constantly monitor the PropSava operational and maintenance status; and in the event of any fault the PropSava will automatically sound an alarm and engage By-Pass.

The standard Surge Protection Device (SPD) is fitted to all PropSava 3 Phase and single phase Power Optimisation Systems is rated at 20KA. There is an upgrade available to 30KA if required/requested at time of build. The purpose of the SPD is to stop any power surges caused by outside sources, natural or man-made, damaging the PropSava and the site/building electrical equipment.

Purpose and Intended Use:

The purpose of the PropSava is to control over or under incoming mains voltage to any site and output voltage as a regulated and stabilised value determined by the power requirements of the site/building. To determine the power requirements of a site/building a minimum period of 1 (one) day of power quality logging is required at the intended site/building.

This power quality logging measures the minimum, maximum and average values of:

- Volts,
- Amps
- Kilowatts

Purpose and Intended Use, Continued...

The sites power usage logged during these 7 days is then checked against 12 months of Electric Bills. This 'check' is to ensure that the 7 days chosen as the logging week is an accurate indication of sites yearly power usage. These values of power quality are then analysed to determine which PropSava Single Phase Systems matches the site/building power output profile. The regulated and stabilised output voltage level is determined by the User and their Installation Engineer at the time of installation. The PropSava can be manually programmed for +/- 25% of the Input value of Voltage. This and other input and output parameters of operation of the PropSava can be changed at any time by the User or their Installation Engineer.

Benefits:

The benefits of such regulation and stabilisation are similar on whether there is over or under voltage situations at the relevant installation site.

Where sites/buildings experience main voltage delivery of over 220V, the electrical equipment is over-powered. Power is wasted and equipment suffers premature failure and reduced life expectancy. Sites/Buildings that have over-voltage supply will:

- Pay more than they need for electricity.
- Experience more electrical equipment breakdowns; higher levels of production loss and higher than normal labour costs for maintenance.
- Replace electrical equipment sooner; increasing the originally projected period for return on investment (ROI) of that equipment, especially in computer systems, lighting and UPS equipment.
- Increase CO² emissions and carbon footprint.
- Increase the Users liability for Carbon Taxes.

PropSava Power Optimisation Systems are used in virtually all forms of industry and commerce: telecoms, factories, offices, petrol stations, department stores, residential apartment blocks, leisure - anywhere that needs to maintain constant output voltage, save power, costs & protect equipment from premature failure.

Whatever the value of the incoming voltage (195V – 265V) into the site, whether it is over or under voltage, the PropSava will always tightly control the User programmed output voltage setting to +/- 1.5 %. It is this powerful and rapid regulation of voltage, coupled with high quality components and build that delivers the significant power and cost savings to our customers.

Mark VII Unique Features:

The Mark VII PropSava is the first PropSava that allows the user to change and program:

1. Output voltage.
2. Maximum Over - Voltage Limit.
3. Maximum Under – Voltage Limit
4. Maximum Power Output Limit

Layout Front:

Display & Control Panel – LED readout and programming all input and output parameters.

Mains LED – when illuminated, main power is ON.

By-Pass LED – when illuminated, By-Pass state exists.

Alarm Mute Switch – when Alarm has been activated, press to silence Alarm.

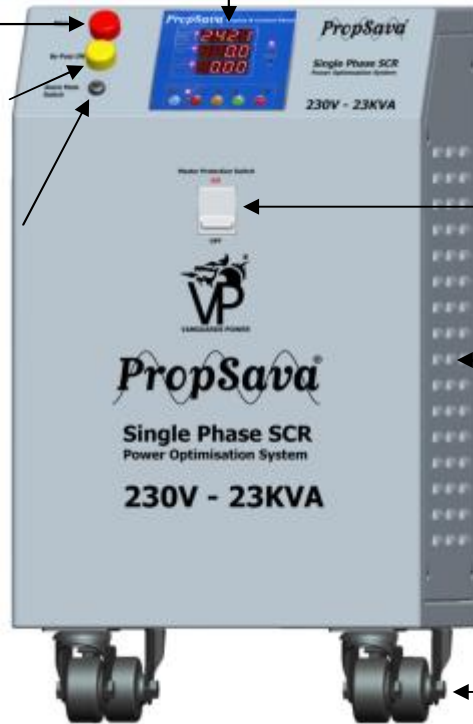

Master Protection Switch – protection circuit breaker for incoming mains power

Side Air Vents - to facilitate air flow cooling. Do not obstruct.

4 wheels – only fitted to 40 Amp units and above. 2 rear wheels bi-directional and 2 front fully directional with wheel locks.

Layout Rear:

Cable Entry Grommets – input and output cable entry points.

Terminal Access Plate – remove the screws to access the terminal connector.

Manufacturers Plate – Identification of model type, power, volts, serial number and date of manufacture.

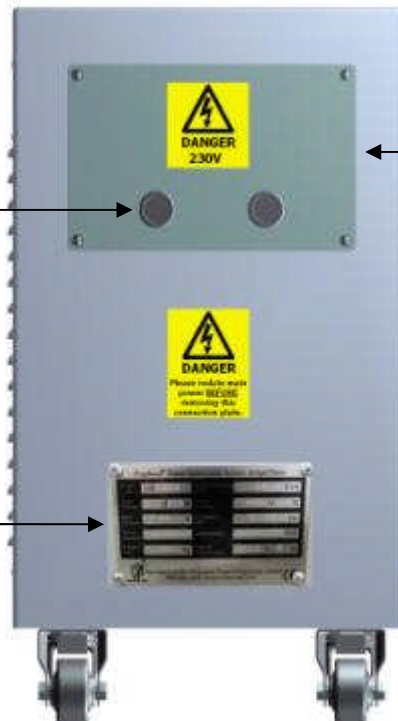

Product Package Contents:

- 1 x PropSava – Available in various KVA sizes. Please see the rear of the unit for the Manufacturers Plate for specific information on power and voltage settings.
- 1 x User Manual

Safety Information:

WARNING:

The PropSava **MUST** be installed by a qualified Electrician who holds nationally recognised qualifications for the installation of electrical high amperage mains equipment. Failure to use a qualified and competent installer can result in fatal injuries. Be sure to turn off the power before installing or servicing any PropSava. Fire can result from loose electrical connections. Ensure that all connections are secure. Local and National codes of installation and safety must be adhered to for the installation of the PropSava. If you do not know or are not familiar with local and/or national codes for the installation of high amperage mains equipment, please contact your local authority building inspector department for advice and/or guidance.

1. Please check that the voltage and power rating of the PropSava matches the voltage and plus 20% load of the property. The information as to the voltage and load of the PropSava can be found on the rear casing on the Manufacturers Plate. There should always be 20% more load ability in the PropSava than the maximum requirement of the property; and at least equal to the maximum loading of the mains power breaker switch of the Fuse/Consumer Box.
2. Check the PropSava for any obvious signs of damage from transportation. Nominal dents on the metal casing are acceptable but there must not be any damage to the Control Panel and/or connection plate.
3. Examine the intended site of installation of the PropSava and ensure that the site has:
 - a) No water leakage, steam, oil-based dust and metal particles.
 - b) No corrosive, flammable, explosive liquid or gas.
 - c) Good ventilation.
 - d) Altitude: ≤ 2000 meters
 - e) Humidity: 0~95% (Not freezing point)
 - f) Ambient temperature: -15 - 50C
 - g) Has a clearance of 100mm above and 50mm on all sides of any surface
 - h) Has sufficient space to carry out a safe installation and maintenance.
4. Be sure to turn off the power before installing or servicing any PropSava to protect you and the PropSava.
5. Always isolate incoming power to the PropSava prior to removing the casing.

Safety Information Continued...

6. Please ensure that the PropSava Mains Protection Switch is in the **OFF** position prior to connection of the Input and Output connections.
7. The PropSava Input side must be connected to the output side of the Electric meter using the appropriate rated size cables and must be earthed in the manner prescribed by local codes. Please see wiring diagram.
8. The PropSava Output side must be connected to the feed side of the Fuse/Consumer Box using the appropriate rated size cables and must be earthed in the manner prescribed by local codes. Please see wiring diagram.
9. Please keep connections runs to a minimum length; but allow enough cable to permit the inspection/maintenance of the PropSava.

Installation:

1. Preparing the PropSava for Installation:
 - a. Unscrew the rear Terminal Access Panel and place to one side. Check that there are 2 brass cable eyes attached to the Input Connector and 2 brass cable eyes connected to the Output Connector block and 1 brass cable eye connected to Earth block.

Terminal Access Panel
Screws, remove to access
Terminal connectors.

Terminal Access Panel
removed to show Terminal
Connector

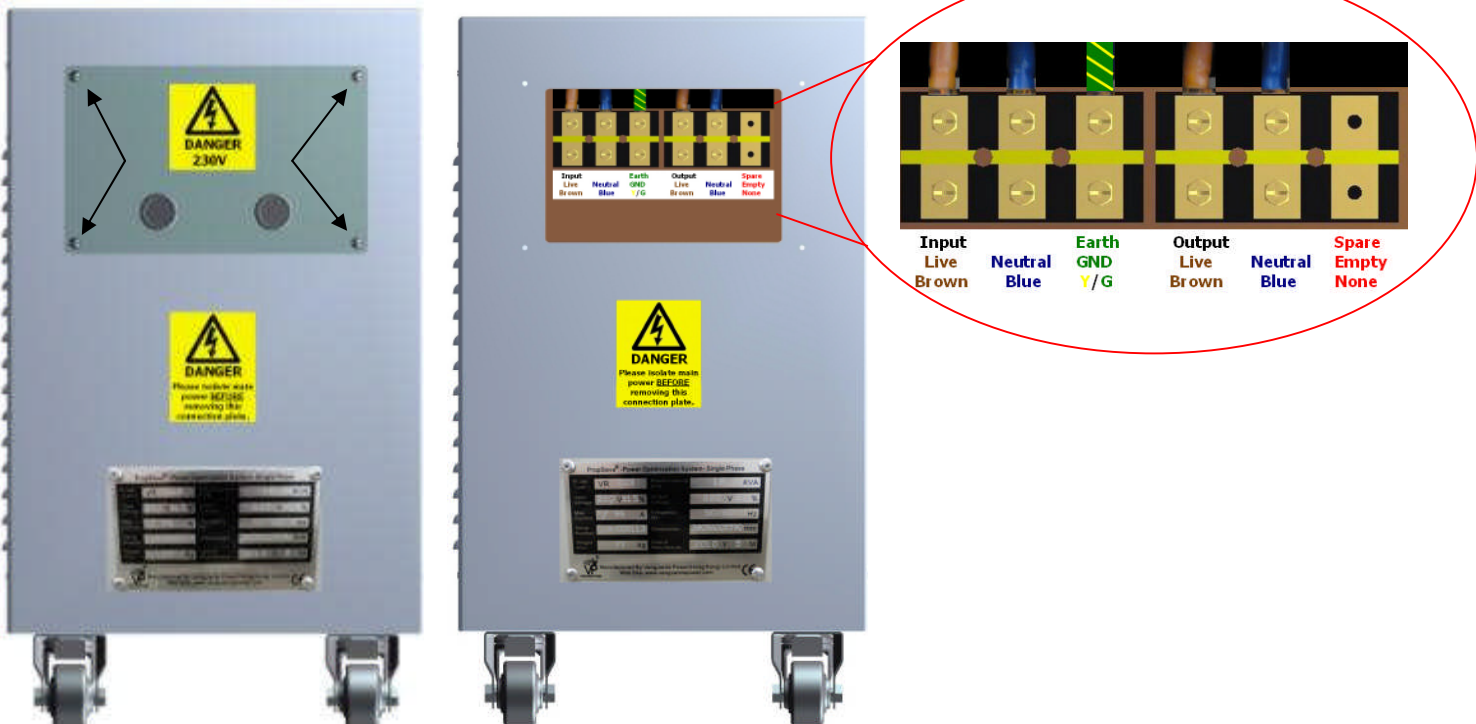

Installation, Continued...

- b. Switch Master Protection Switch of the PropSava to **OFF** position.
 - c. Use a multimeter or megohmmeter to check resistance between Input and Output terminals of PropSava to earth and ensure that it is more than 1Mohm. If not, then check environmental Humidity conditions; check for dirty contacts, dampness around the terminal block and rectify prior to installation.
2. Please follow all local codes on cable sizes, however, we recommend the minimum sizes for the Input/output cable as shown below:

Load (KVA)	Input voltage	Output voltage	Maximum Current	Input/output phase cable	Ground cable
5KVA	220V \pm 20%	220/210 \pm 1.5%	27A	6 mm ²	6 mm ²
12KVA	220V \pm 20%	220/210 \pm 1.5%	65A	16 mm ²	10 mm ²
18KVA	220V \pm 20%	220/210 \pm 1.5%	96A	25 mm ²	16mm ²
23KVA	220V \pm 20%	220/210 \pm 1.5%	123A	30 mm ²	25mm ²

3. Identify all lengths of cable runs required and connect the Input and Output cable eyes to your cables. Then connect the cables to the correct Input and Output cable block using the cable eye screws provided. Please ensure that you tighten the cable eyes screws.
4. Switch off the Master Switch at the Fuse/Consumer Box and remove existing input power cables and replace with the new PropSava Output cables.
5. Remove the output cable from the electric meter and replace with the Input cables of the PropSava.

Wiring Diagrams:

Diagram 1: Existing Wiring Connection from Electric Meter to Distribution/Fuse Box.

Diagram 2: PropSava installed between the Electric Meter and Distribution/Fuse Box .

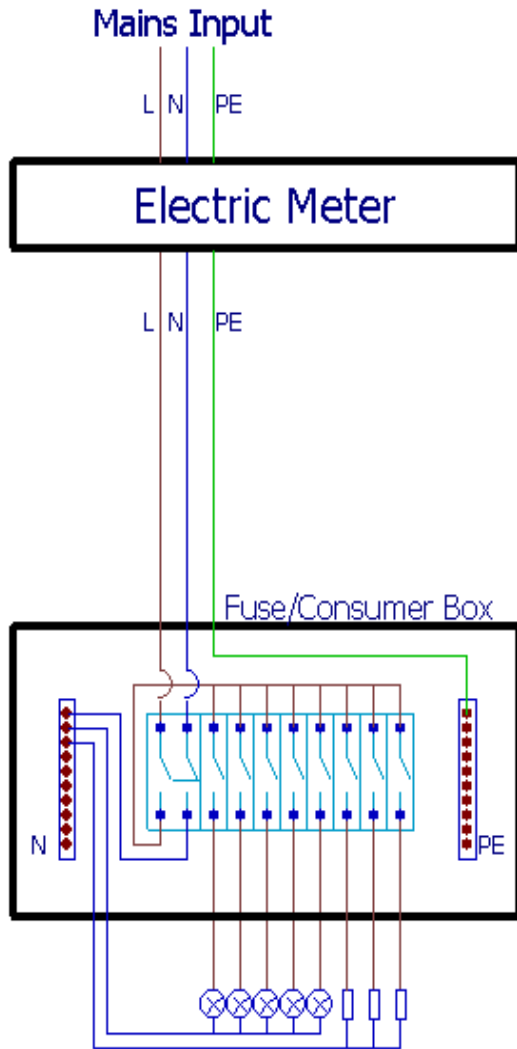

Diagram 1

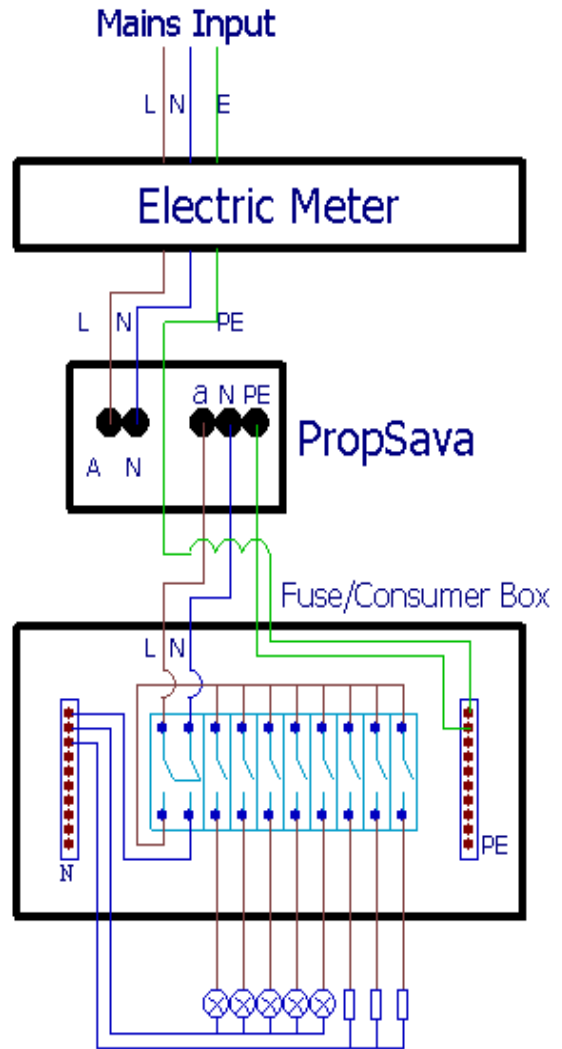

Diagram 2

1st Post Installation Test – No Load

1. Switch **OFF** the Master Switch of Distribution/Fuse Box and each sub-circuit RCB then switch **ON** the Master Protection Switch of the PropSava. The PropSava will default to **Regulation ON**
2. Check the PropSava display panel to see that the **Regulation** LED indicator is illuminated. You should now see the regulated Output voltage of 220V +/- 1.5% (if still at the factory default setting).
3. Press the **R/B** button and check that the PropSava switches to **By-Pass** mode. The red coloured LED next to the **By-Pass** button should illuminate. The Output Voltage LED display should now show the existing value of incoming mains voltage.
4. To re-start the PropSava either:
 - a) Press **R/B** button on the Display/Control Panel again to place the PropSava back to **Regulation** mode or,
 - b) Switch off the PropSava Master Protection Switch; wait 5 seconds and then turn ON the Master Protection Switch again.
5. The Display/control panel output voltage should now be showing the regulated voltage of 220V (factory setting) or the value you have programmed +/- 1.5%.
6. Now switch **OFF** the Master Protection Switch of the PropSava to prepare for the 2nd Post Installation Test below.

2nd Post Installation Test – with Load:

1. Ensure that the Distribution/Fuse Box Master Switch is still **OFF**.
2. Switch **ON** the Master Protection Switch of the PropSava. The PropSava will default to **Regulation ON**.
3. Switch **ON** the Master Switch of the Distribution/Fuse Box and Switch **ON** the sub-circuit RCB's one at a time.
4. Ensure that the PropSava does not show any faults or go to By-Pass.
5. If there is/are any faults shown on the PropSava, please identify which LED's faults are indicated and contact Customer Support.

Service and Maintenance:

The PropSava has no parts that need regular servicing and/or maintenance. However we recommend that annual checks for safety and performance are carried out by a qualified electrician. As an absolute minimum, we recommend that every 10 (ten) years of service the Control Board be inspected and tested for safety and/or performance.

Display & Control Panel – Description of Function and Controls:

LED Indicators

showing that the Output Screen is being displayed

LED Indicators

Manual By-Pass ON

Regulation ON



Power Display Default Screen

Output Voltage

Output Amps

Output Kilowatts

Event/Alarm LED Indicators

- ▶ OLP—Overload Protection-Event
- ▶ OVP—Over Voltage Protection-Event
- ▶ UVP—Under Voltage Protection-Event
- ▶ Message – An Event Has Occurred

1. Regulation ON
OR Manual By-Pass ON
2. Enter
3. Up Arrow
4. Right Arrow
5. Display

Description of Function and Controls:

1. The **"R/B"** button has two functions; to switch on the regulation function of the PropSava and also to manually turn off the regulation and place the PropSava in **'By-Pass'**. **By-Pass** is the system of by-passing the PropSava regulation system by directly connecting the incoming mains power to the outgoing mains. In the **By-Pass** state the PropSava is live but it is not regulating the power (reducing or increasing the voltage). The **By-Pass** system also operates automatically when the Control System identifies either voltage or power above the safe settings of the PropSava or if an internal fault is detected. This ensures that the PropSava always supplies power to the property or site under any condition.

2. The **"Enter"** button has three functions:

- a) To enable the computer programming system when you want to start programming on a Display screen;
- b) To save the changes made to any settings in the various display screens into the computers program memory and;
- c) To open a special Display page that cannot be accessed by the **"Display"** button.

Description of Function and Controls Continued....

3. The "**Up Arrow**" button is used to scroll the number or value to your newly selected value on each of the LED screens. Repeated pressing of the **Up-Arrow** button will increase the value displayed in increments of 1. Stop pressing when you reach the value you require and then press **Enter** to store the new value.

4. The "**Right Arrow**" button is used to move the cursor to the next LED character to the right. Repeated pressing of the **Right Arrow** will move the cursor through each of the LED characters of each row of the LED screens. When you have moved the cursor to the desired character to change, use the **Up Arrow** to change the value and press **Enter** to memorise the changes.

5. The "**Display**" button changes the display panel. By changing the **Display** panel you can access the LED screens and make changes to the settings of the **PropSava**. There are 3 display screens. Each press of the **Display** button will change to a different screen. After 60 seconds of non activity on that screen, the display will default to the **Power Display** screen.

How to Change PropSava Settings:

1. All change of PropSava settings must be made in **By-Pass** mode – Push **R/B** button and ensure that the **By-Pass** LED is illuminated.
2. Press the **Display** button to change the **Display** to either **Power**, **Protection** or **Set** screens.
3. On the selected screen, press the **Enter** button. The first character on the top set of LED will now flash.
4. Use the **Up-Arrow** to change the character up. Keep pressing until you have arrived at the number you want. If you pass the character you wanted, keep pressing the **Up-Arrow** until you arrive at the number required.
5. If this is the only change you wish to make then press the **Enter** button to save the entry. If you wish to change further settings, use the **Right-Arrow** to move to the next character or next row of LED's.
6. When you have completed all your setting changes, please make sure to press the **Enter** button to save your new settings. If the **Display** screen changes to the Default screen (Power) and you have not pressed the **Enter** button your changes will not have been saved. You will then need to start again.

Display Screens:

Power Display Screen – Default Screen: Shows the Output Voltage, Output Amps and Output Kilowatts. You cannot change the values of the Power Display as these are the measured output values of your electrical system.

Output Voltage – as PropSava is in By-Pass mode, this value shown on the image is the value of incoming main voltage. When NOT in By-Pass Mode, this value of voltage will show the output voltage set by the User +/- 1.5%.

Output Amps – The current used by the site.

Output Kilowatts – The kilowatts used by the site.

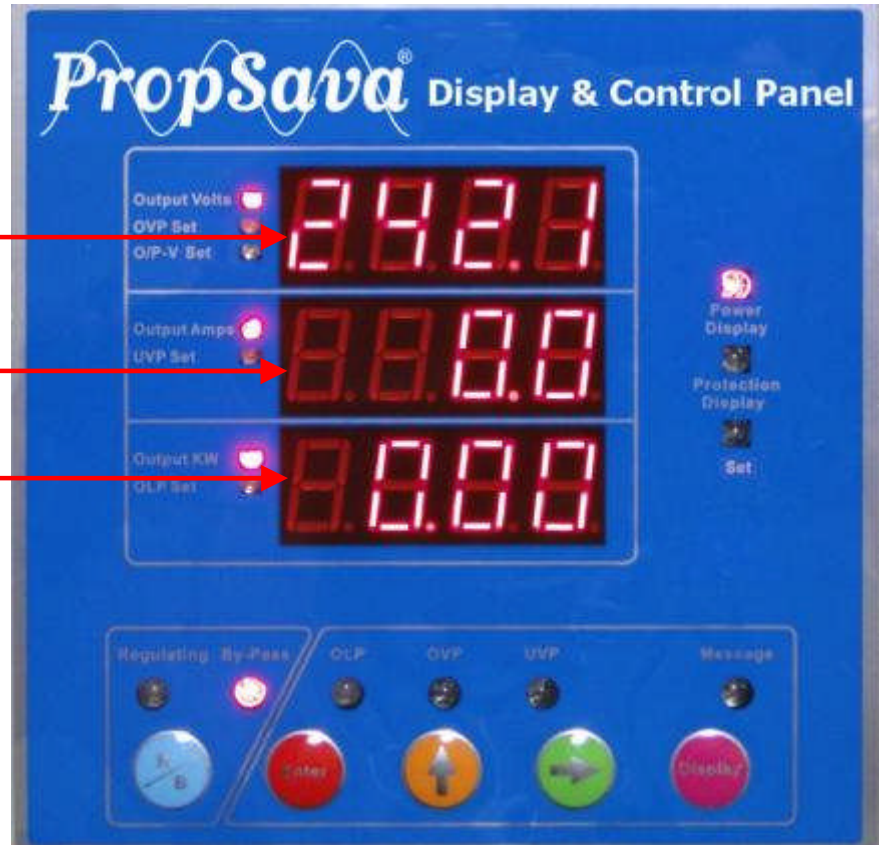

Display Screens continued.....

Protection Display Screen – Shows the User settings of Maximum Output Voltage, Minimum Output Volts and Maximum Output Amps.

1. **Maximum Output Voltage – OVP Set:** Here you can change the Maximum Output Voltage value. Maximum Output Voltage value is 250V. Factory default is 250V. Should the Output Voltage exceed this setting, the PropSava will automatically go to **By-Pass** mode.
2. **Lowest Output Volts – UVP Set:** Here you can change the Minimum Output Voltage value for Outgoing Voltage. Minimum voltage value is 190V. Factory default is 190V. Should the Output voltage fall below this setting, the PropSava will automatically go to **By-Pass** mode.
3. **Maximum Output Amps – OLP Set:** Here you can change the Maximum output Amps of the PropSava. The Maximum level is a maximum of 20% more than the rated output power of the PropSava. Factory default is +10% of the rated output Amps of the PropSava. Should the site electrical system draw more than the setting, the PropSava will automatically go to **By-Pass** mode.

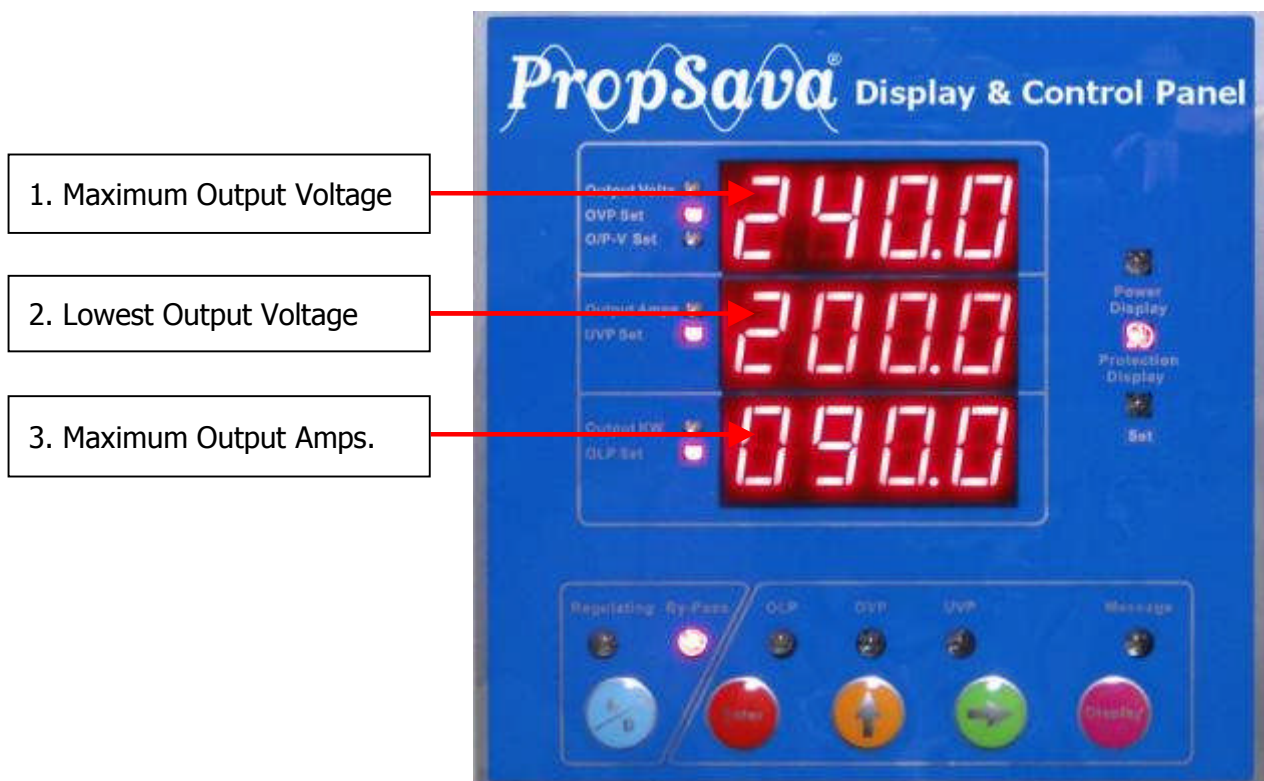

Display Screens continued.....

Set Display – Shows the Output Voltage, Output Voltage Stabilisation Percentage (cannot be changed, reference only) and SCR speed in milliseconds which also cannot be changed.

1. **Output Voltage Setting – O/P-V Set:** Here you can change the Output Voltage value that the PropSava will immediately regulate voltage to when powered on. Maximum voltage value is 230V and Minimum voltage value is 210V. Factory default value is 220V.

- 1. Output Voltage Setting.
- 2. Voltage stabilising rate as percentage – cannot be changed.
- 3. Speed of regulation in milliseconds – cannot be changed.



Events and Alarm Buzzer:

1. In the event of any of the Protection settings being breached, the **By-Pass** will automatically engage and an audible Alarm will activate.
2. The breached setting will be identified by one of the **Event/Alarm** LED being illuminated.
3. If any internal fault occurs in the PropSava including main control board failure, SCR, Transformer etc., the **By-Pass** will automatically engage and audible Alarm will activate.
4. **PLEASE NOTE:** The Alarm Buzzer will **also** activate if **By-Pass** has been activated manually.

Muting the Alarm Buzzer:

To mute the Alarm Buzzer press the **Mute** button on the side of By-pass LED indicator.

Resetting the PropSava after an Alarm:

Providing that the reason for the engagement of the automated **By-Pass** state has been corrected, press the **By-Pass** button on the Display and Control Panel once to reset the PropSava to "ON" mode regulation. Normal regulation will restart if the fault has been rectified; if not the system will activate the alarm and enter By-Pass state again. If you cannot rectify the condition that is activating the **By-Pass**, please contact your installation engineer or supplier.

Working Principle:

1. Compensation unit consists of a compensating transformer, regulation transformer and contactless switches – SCR's.
2. Sampling circuit consists of output voltage/current sampling with Voltage and Current sensing systems.
3. Master control board consists of CPU, interface, SCR drive circuits, internal Power Regulation etc.
4. Display and Control Panel consists of LED display, buttons and interface ICs.

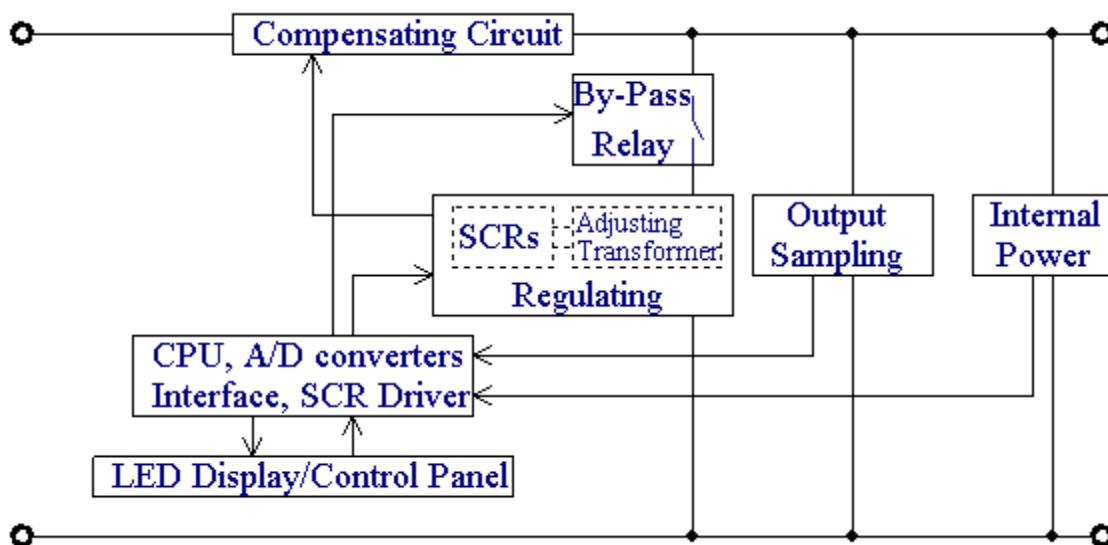

Power Quality Management System (PQMS):

This optional system is available on Vanguards Power single and 3 Phase PropSava and LiteSava products.

PQMS consists of a smart metering system with management software.

PQMS software is a Windows-based application primarily used to configure and retrieve data from the metering system. This software allows Users to see current and past power quality readings with customisable displays, presented as tables or as graphs.

PQMS provides multi-users with seven access levels. Wizards enable easy set up of common operational functions like adding and changing sites/VPHK Systems, reading files, task files, schedules and system information.

PQMS displays instantaneous power quality readings which are stored in the database for analysis at any time.

- Configuration of a single or multiple VPHK Systems.
- Real time display of voltage, current, Kilowatts, power factor, waveform, harmonics, alarms etc.
- User access levels: Read Only Access (RO), Read & Write Access & Read, Write & Modify.
- Data retrieval (event logs, alarm logs, sag/swell logs, tamper logs) to generate reports.
- Schedule downloads of historical data on a daily, weekly, fortnightly, and monthly basis.
- Data export to OLEDB/ODBC databases for storage and management.
- Customisable features and menus.
- Device/meter communication options such as TCP/IP, UDP/IP, RS485/232, PLC, GSM/GPRS.
- Supports multiple languages

Benefits for Users:

- Management in 'real-time' of entire site(s) energy usage.
- Comparison of energy usage to calculate where savings can be maximised.
- Equipment Failure Alarms- Instant knowledge of problems site(s) wide.
- Time of Use – Identify where energy is used at different times of the day, week or year.
- Multi Metered Sites- To compare which sites perform the best in energy savings and use.
- Use collected data to construct a full energy saving plan to cut costs.
- Accurately show energy savings for Carbon tax credits.

Power Quality Management System (PQMS) – Continued...

Meter Positioning:

The meter is positioned/mounted in various positions in the single and 3 Phase PropSava and LiteSava. Below we show the position in a 3 Phase PropSava SCR series, mounted in the lower part of the case.



PQMS meter mounted inside 3 Phase SCR PropSava



LAN/P.C - External connection – lower rear left case on a 3 Phase PropSava.

Connectivity:

Connectivity comes in the form of a J45 connection allowing for direct connection to a LAN network. Alternatively a USB connection can be fitted for use with a Laptop.

An optional Dynamic or Permanent GPRS system can be used for a full wireless network. This will require a GPRS enabled modem with a GPRS connection that uses a fixed IP based system.

Software Application:

PQMS software is a 32 bit Windows-based application primarily used to configure and retrieve data in a user-friendly manner from the metering system. It can keep track of single or multiple meters spread across multiple sites. This software allows Users to see current and past power quality readings with customisable displays, presented as tables, waveforms or as graphs.

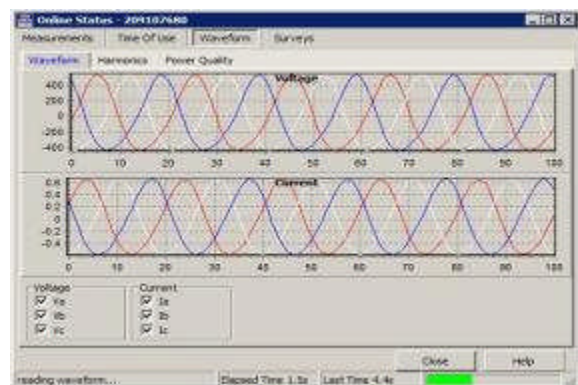
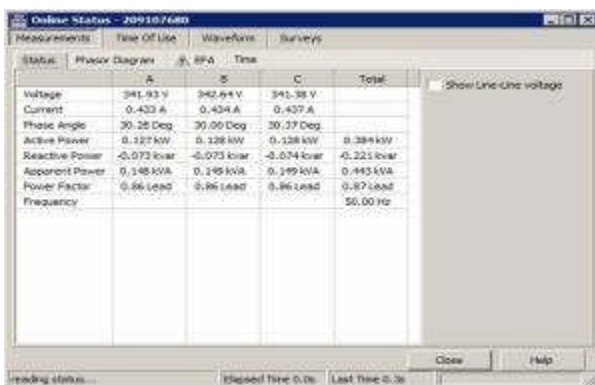

Example Screens, showing on line readings in a table and waveform format.

The PQMS software is provided with a Tutorial section enabling the user to familiarise themselves with all applications; from setting up the meter to customising the relevant data required for live applications and historical records.

Power Quality Management System (PQMS) – Continued...

Security:

Security is controlled by PQMS using usernames and passwords on a meter by meter basis. When PQMS loads it prompts for a username and password.

The meter allows for up to six (6) users, before any operations can be performed a user must log on. Each user has a user name and password, each up to 7 and 15 characters long respectively. The user remains logged on until logged out.

Each user has a user level security access to the system subject to Administrator given rights. There are 7 user levels of security numbered 0-6 as outlined below with 6 being the highest level of access.

Number	Access	Description
0	Read only	Only allows values to be read
1	Read All/ Limited Timeset	Also allows the time to be set by a limited amount, as per the shift limit setting.
2	Read All/Billing Reset	Also allows a billing reset to be performed.
3	Read All/Clear	Clear EFA alarms, surveys and other systems. Control user programmable pulsing outputs. Unlimited timeset ability.
4	Read All/+Setup/ Write User	Allows the setup to be read, and allows limited setup change. Added in firmware version 1.27
5	Read All/+Setup	Allows the setup to be read, but not written.
6	Read/Write All	Allows the setup of the meter to be changed.

The seven levels of User Security Rights which are set by the Administrator

Alarms:

During operation the metering system monitors a variety of external and internal conditions. If a problem is detected an alarm is raised called an 'Equipment Failure Alarm' or EFA. These tests are designed to detect measurement failure, tampering attempts and hardware failure.

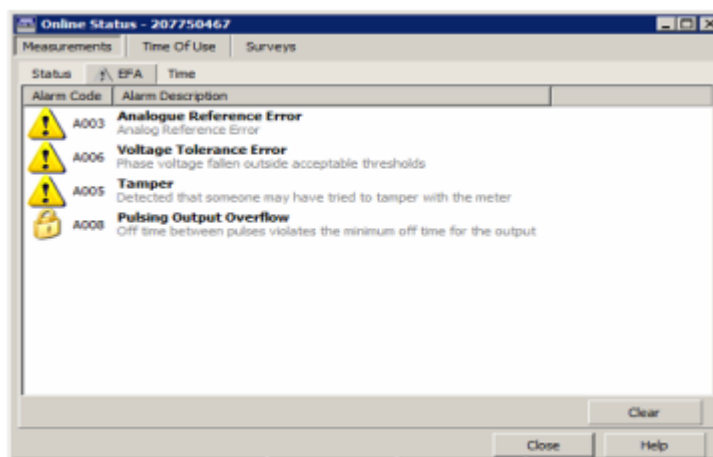

Power Quality Management System (PQMS) – Continued...

There are 17 alarms each representing a different fault. Each alarm has a corresponding flag letter that represents it.

Flag Letter	Alarm Name	Alarms Page Code
E	Analog Reference Failure	A003
S	Asymmetric Power on Mk10 Neutral current Mismatch on Mk7	A000
V	Voltage Tolerance Error.	A006
F	VT Failure.	A007
R	Incorrect Phase Rotation. (not on Mk7)	A002
T	Lid Tamper	A005
C	Clock Failure.	A017
M	Reverse Power.	A004
L	Calibration Data Lost.	A001
H	Modem Failure.	A012
X	RAM Failure or LCD Failure.	A015
Y	Program Flash Failure.	A015
Z	Data Flash Failure.	A015
N	Pulsing Output Overflow.	A008
D	Battery Failure	A016
U	Tamper	A005
O	Overcurrent (Extra EFAs group)	

Alarm names and Flag letters

An Alarm Flag can have one of 3 states. The Active state means that the alarm has been detected and is still occurring. The latched state means the alarm was active but is not active now. The inactive state means the alarm is not active and has not been in the past.

Event Logs:

The PQMS keeps a record of a variety of events that occurs to the Meter. The size of these logs may be configured.

Log Name	Description
System Log	Used for system events like power on and off.
Access Log	Used to track user accesses to the meter.
Tamper Log	Records when tamper events occur. (Also used as LCD Alarm LOG for UPS meters, and previously was used as a billing reset log)
Sag/Swell Log	Records Sag and Swell events.
Debug Log	Only used for diagnostics. Also used as the Push Alarm log for UPS meters and meters with Push alarming enabled.

Event Log Types

Power Quality Management System (PQMS) – Continued...

Event logs can be downloaded as a text file. Each file has a unique number starting from when the meter was started, which is only reset if a survey is cleared. Each Log can be cleared individually.

[LoadSurvey]

LastRecord=0000000061

StartTime=01/01/1996 00:20:50

Record No	DateTime (0x0000F03D)	Event (0x0000FFFF)
34	01/01/1996 21:39:50	User: 1 changed database stage: Misc=>2041
35	01/01/1996 21:39:55	User: 2 changed database stage: Pulse=>2042
36	01/01/1996 21:39:57	Log off port: Optical=>2081
37	03/01/1996 07:56:58	User: 0 logged in on port: Optical=>2000
38	03/01/1996 07:56:58	Bad password on port: Optical=>2080
39	03/01/1996 07:56:58	User: 0 logged in on port: Optical=>2000
40	03/01/1996 07:57:28	Inactivity timeout on port: Optical=>2082

Downloaded Event Log

Time of Use (TOU) Channels:

An energy quantity such as KW/h is recorded in a TOU channel. Each TOU channel records both accumulated energy; the maximum demand; and the time maximum demand occurred. It can record these quantities separately for different times of the day, week, seasons, special periods, and year. Hence the term 'Time of Use'. The calendar allows different rate structures for different days of the week and for different special days during the year. It can take account of seasons or complete customised rate conditions.

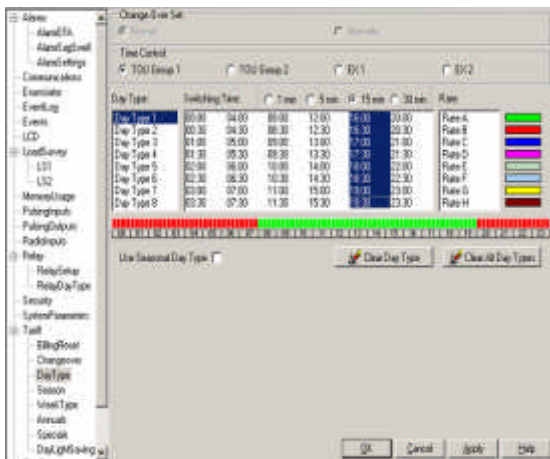

Day type TOU set up

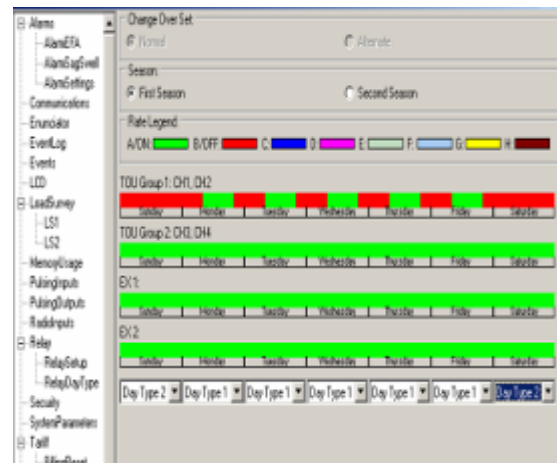

Week type TOU set up

Power Quality Management System (PQMS) – Continued...

Load Survey:

A load survey is designed to give a detailed record of energy usage. PQMS has two load surveys available each independently programmable and each can record up to 32 channels. The load surveys in PQMS also have the ability to record instantaneous figures such as voltage and current. Load Surveys can be downloaded as text files, similar to Event Logs.

The Load Survey on line status screen allows periods of time to be downloaded or entire surveys.

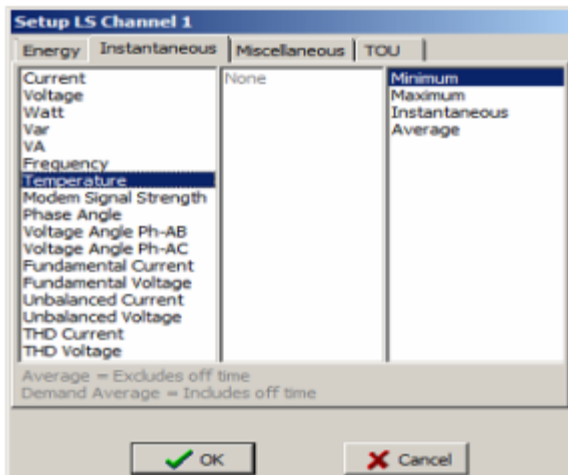

Instantaneous Channel selection

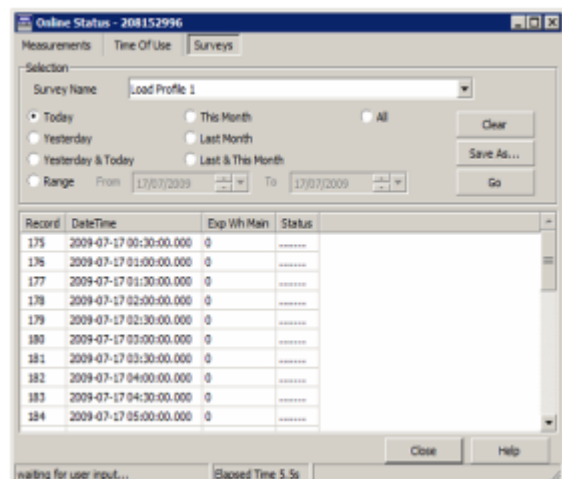

Load Survey On-Line Status

Specifications:

PropSava Type Mark VII:		VR-201	VR-202	VR-203	VR-204
Capacity:		5KVA	12KVA	18KVA	23KVA
Input voltage for all models:		185 – 260V at 50Hz			
Output voltage for all models:		195V - 230V			
Output Maximum Current:		27A	65A	96A	123A
Efficiency:		≥98%			
Response time:		≤40ms			
Additional Waveform distortion:		Less than 0.4%.			
Output Voltage Stabilisation:		≤±1.5%			
Protection:	Over voltage:	If output voltage is above setting (default 230V) for 5 seconds the system will activate automatic By-Pass and an audible alarm (buzzer) will activate.			
	Under voltage:	If output voltage is under setting (default 190V) for 5 seconds the system will automatically activate By-Pass and an audible alarm (buzzer) will activate.			
	Over load:	If output current exceeds 120% of maximum rated current for 20 seconds, then system will automatically enter By-Pass state. An audible alarm (buzzer) will activate.			
	Surge Protection:	IEC class II surge protection. Nominal discharge surge current is 20KA.			
	By-pass:	Automatic/Manual. In the event of any internal fault such as blown fuse, SCR damage, internal power failure or external fault such as over/under voltage, over load etc the system will automatically activate By-Pass and an audible alarm (buzzer) will activate.			
EMC and Safety	EMC:	EN61000-6-1:2007 and IEC 61000-6-1:2005 EN61000-6-3:2007 and IEC 61000-6-3:2006 EN61000-3-2:2006 and IEC 61000-3-2:2009 EN61000-3-3:1995+A1:2001+A2:2005 and IEC 61000-3-3:2008			
	LVD:	EN61558-2-12:2002 and IEC 61558-1:2005/A1:2009 and IEC61558-2-12:2001			
Life cycle:		Designed for 10 years minimum, up to 25 years subject to 10 year service intervals.			
Others:	Display:	Fully User programmable settings with digital meter that shows output voltage, Amps, Kilowatts, Over & Under Voltage and Over Amps settings.			
	LED indicator:	Mains ON, By-Pass ON.			
	Cooling:	Temperature controlled, low noise, long life Fan for over 18KVA Systems			
	Working temperature:	≤65C			
	Ambient temperature:	-15 - 50C			
	Humidity:	0~95% (Not freezing point)			
Physical:	Dimensions (H x W x D cm)	60 X 36 X 36	70 X 40 X 40	70 X 45 X 45	80 X 50 X 50
	Net Weight:	40KG	65KG	78KG	92KG
	Enclosure:	IP22			
	Feet:	All PropSava have 4 wheels (two lockable) and are floor standing.			

Surge Protection System:

Overview:

All PropSava Single Phase Systems have a surge arrester fitted as standard. The surge arrester protects the PropSava and also the entire site/properties electrical equipment. Surges are short-duration peak voltages – i.e. transient voltages – existing for only milliseconds; but can measure thousands of volts.

These surges are caused by:

1. Direct lightning strikes
2. Indirect lightning strikes within a distance of some kilometres
3. Switching operations in the power supply system
4. Faults due to switching operations within the installation

In the commercial sector, lightning or power surges cause 45% of electrical equipment damage. Overall, 28 out of 100 cases of damage to electronic equipment are caused by surges. Surges are by far the most frequent cause of damage and that is why surge arrestors are fitted as standard.

PropSava-Single Phase Standard Surge Arrester installed V 20-C/1+NPE-280 technical data:

Note: alternatives such as ABB, DEHN, PHOENIX, Schneider maybe used without notice.

Surge Controller surge arrester Description	V 20-C/1+NPE-280
Maximum continuous operating voltage U_c	280 V~
LPZ	1 → 2
Requirement class to VDE 0675, Part 6 (Draft 11.89) A1, A2 to IEC 61643-1	C Class II
Tested to:	IEC 61643-1, pr EN 61643-1, E DIN VDE 0675-6:1989-11 and Part 6/A1
Nominal discharge current of the upper part I_n (8/20)	20kA
Maximum discharge current of the upper part I_{max} (8/20)	50 kA
Voltage protection level at 1 kA (8/20) U_p at 5 kA (8/20) U_p at I_n U_p	≤ 1.2 kV ≤ 1.5 kV ≤ 1.8 kV
Response time T_a	<25 ns
Short-circuit – to withstand 25 kA with max. upstream fuse	125 A gL/gG
Connection cross-section	2.5-35 mm ² (single and multi stranded); 2.5-25 mm ² (fine-stranded with core end sleeves)
Mounting	Snap-fitting on 35 mm top-hat rail to DIN EN 50 022
IP Code	IP20
Temperature range	-40°C to +80°C

PropSava-Single Phase Optional Surge Arrestor type V 25-B+C/1+NPE-280 technical data:**Note: alternatives such as ABB, DEHN, PHOENIX, Schneider maybe used without notice.**

Surge Controller surge arrester Description	V 25-B+C/1+NPE-280
Maximum continuous operating voltage U_c	280 V \sim
LPZ	0 \rightarrow 2
Requirement class to VDE 0675, Part 6 (Draft 11.89) A1, A2 to IEC 61643-1	B+C Class I+II
Tested to:	IEC 61643-1, pr EN 61643-1, E DIN VDE 0675-6:1989-11 and Part 6/A1
Nominal discharge current of the upper part I_n (8/20)	30KA
Maximum discharge current of the upper part I_{max} (8/20)	50 kA
Voltage protection level at 1 kA (8/20) U_p at 5 kA (8/20) U_p at I_n U_p	≤ 0.9 kV ≤ 1.2 kV ≤ 1.5 kV
Response time T_a	<25 ns
Short-circuit – to withstand 25 kA with max. upstream fuse	160 A gl/gG
Connection cross-section	2.5-35 mm ² (single and multi-stranded); 2.5-25 mm ² (fine-stranded with core end sleeves)
Mounting	Snap-fitting on 35 mm top-hat rail to DIN EN 50 022
IP Code	IP20
Temperature range	-40°C to +80°C

PropSava Fault Finding and Recommendations for Electricians ONLY:

NOTE: In the unlikely event of any fault developing on the PropSava, the automated **By-Pass** system will be engaged and the electrical power from the mains supply will be diverted **DIRECTLY** to the Fuse/Consumer Box. The User of the PropSava may be able to restart the PropSava by turning the Master Protection Switch of the PropSava Off then On. If this does not restart the PropSava –please call your service centre and/or the installing Electrician.

WARNING:

DO NOT ATTEMPT, UNDER ANY CIRCUMSTANCES, TO REMOVE ANY WIRES AND/OR PANELS OF THE PROPSAVA. ALL THE CONTROLS OF THE PROPSAVA ARE EXTERNAL THAT CAN BE OPERATED BY THE USER. ALL OTHER EXAMINATION OR WORK MUST BE CARRIED OUT BY A QUALIFIED ELECTRICIAN. FAILURE TO OBSERVE THIS WARNING MY RESULT IN SERIOUS INJURY FROM ELECTROCUTION AND MAY BE FATAL.

Fault Description:	Reason:	Recommendations:
No operation	1. No power 2. Master Switch not in on position 3. Shut down	1. Check the input cable connection and input voltage 2. Switch on Master Switch. 3. Intermittent high load or short circuit event. The PropSava has shut-down. Reset the Master Protection Switch.
By-Pass LED On.	4. Over load 5. Fuse blown 6. Over Voltage/Under voltage output limit exceeded.	4. Check lighting system load for short circuit or over load. 5. Contact Customer Support to arrange for replacement fuse. 6. Check the User setting of input and output voltage.
No Display	7. Loose connection from main control board 8. Main board power failure	7. Check connection. 8. Check power supply.
Relay Noise	9. Incoming voltage too low	9. Check User setting for input voltage

Declaration of Conformity:

The Manufacturer of the Products covered by this Declaration is:

Vanguards Power (Hong Kong) Limited
1508 Eastern Tower, Yihai Square,
Commercial Building
North Chuang Ye Road, Nanshan, Shenzhen.518054, China

Company Registered in Hong Kong Number: 1125122

The Directives covered by this Declaration:

Council Directive 89/336/EEC and LVD Directive 73/23/EEC, including amendment 2004/108/EC and 2006/95/EC-Council Directive Amending Directives.

The Product Covered by this Declaration is the PropSava® 230V, 60KVA 40KVA, 30KVA, 23KVA, 18KVA, 12KVA and 5KVA Power Optimisation System.

The Basis on which Conformity is being declared:

EMC Test Standards:	EN61000-6-1:2007 and IEC 61000-6-1:2005 EN61000-6-3:2007 and IEC 61000-6-3:2006 EN61000-3-2:2006 and IEC 61000-3-2:2009 EN61000-3-3:1995+A1:2001+A2:2005 and IEC 61000-3-3:2008
LVD Test Standards:	EN61558-2-12:2002 and IEC 61558-1:2005 IEC 61558-2-12:2001

The manufacturer hereby declares under his sole responsibility that the products identified above comply with the protection requirements of the EMC directive and with the principal elements of the safety objectives, and that the standards have been applied.

The technical documentation required to demonstrate that the products meet the above requirements has been compiled and is available for inspection by the relevant enforcement authorities. The CE mark was first applied in September 2009.

Warranty Terms & Conditions

1. These Terms and Conditions do not affect your statutory rights.
2. Please check the LiteSava package and contents as soon as possible. If the LiteSava or any other item included in the package is damaged or faulty, you must inform your supplier immediately or at the latest within 7 (seven) days of the date of purchase. If the supplier you purchased it from does not offer an exchange and/or replacement service, we will arrange collection and replacement at our cost. If you do not inform us within 7 days we shall have no liability for the LiteSava said to be damaged and/or items missing at time of purchase.
3. Vanguards Power (Hong Kong) Limited, hereafter referred to as "VPHK" guarantee that the LiteSava will be free from defects for 10 (ten) years from the date of purchase, subject to completion, supplier stamping and the registering with VPHK of the attached Warranty Card. If no Warranty Card is registered with VPHK within 3 months of the date of installation, the LiteSava will be warranted for 1 year from date of installation. If LiteSava does not conform to this Warranty then we will at our option either remedy the defect in question or replace the LiteSava, or refund the price paid, subject to sight of the original receipt from the supplier where it was purchased.
4. Subject to registration of the completed and supplier stamped Warranty Card, the first 10 (ten) years of Warranty covers parts and labour. The warranty period commences on the day of successful installation by a qualified electrical Engineer. Any repairs or parts supplied or other work carried out which are found to be outside the terms of this warranty will be charged to the purchaser, and will be payable at the point of service. If no fault is found or the fault is outside the scope of the warranty then a possible charge for labour and transportation may also be made.
5. The purchaser must ensure the environmental and power supply conditions are suitable for the LiteSava and that the LiteSava is cared for and maintained in accordance with the recommendations stated in this User manual.

Exclusions to the Warranty:

6. Breakdowns or failures arising from any external influences such as misuse, neglect, accidental damage, inadequate ventilation/temperature control of the area of installation, harmonic wave distortion, power factor below 0.8, short circuits, loading to the LiteSava above the original specification of build, any unauthorised tampering with the system and/or its software, and other external influences such as, but not limited to poor environmental conditions.
7. Purchaser's consequential loss or liability of any kind.
8. We do not accept liability for returns damaged in transit or not received by us.
9. Every care has been taken in the preparation of all and any details or statement made in this User Manual and the LiteSava packaging. However, as far as is permitted by applicable law, we disclaim all warranties, express or implied as to the accuracy of information contained herein.

Warranty Card: Please complete all sections.

KVA Size: _____ Voltage Rating: _____ Serial Number: _____

Date of Installation: _____ Installer/Engineer Name: _____

Installer/Engineer Company Name: _____

Installer/Engineer address: _____

_____ Country: _____

Installer/Engineer Statement: I confirm that the above stated PropSava has been installed in accordance with current building and electrical code(s) of safety and conditions specified in the User Manual for such products. Signed: _____ Dated: _____

Name of Customer or Company: _____

Name of Contact: _____ Telephone (Incl. Country code): _____

Address of installation: _____

_____ Country: _____

Distributor Name: _____

Distributor Stamp:



Dated: _____ Signed on behalf of authorised Distributor: _____